

SONY®

TRINITRON® COLOR VIDEO MONITOR

PVM-8220/8221

OPERATING INSTRUCTIONS Page 2

Before operating the unit, please read this manual thoroughly and retain it for future reference.

MODE D'EMPLOI Page 8

Avant la mise en service de l'appareil, lire attentivement ce mode d'emploi et le conserver pour toute référence ultérieure.

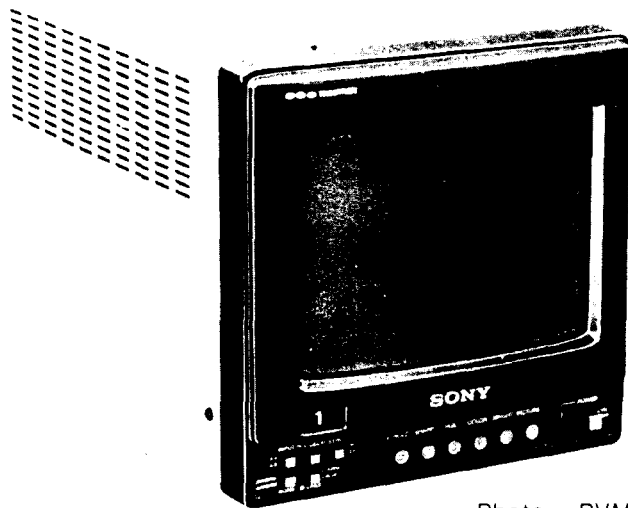

Photo : PVM-8220

OWNER'S RECORD

The model and serial numbers are located on the rear of the unit. Record these numbers in the spaces provided below.

Refer to them whenever you call upon your authorized Sony dealer regarding this product.

Model No. _____ Serial No. _____

For customers in the U.S.A.

WARNING

To prevent fire or shock hazard, do not expose the unit to rain or moisture.

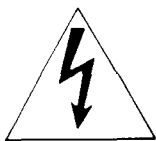
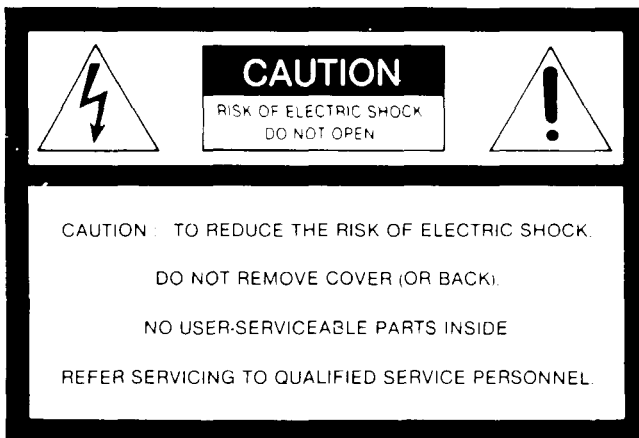

This symbol is intended to alert the user to the presence of uninsulated "dangerous voltage" within the product's enclosure that may be of sufficient magnitude to constitute a risk of electric shock to persons.



This symbol is intended to alert the user to the presence of important operating and maintenance (servicing) instructions in the literature accompanying the appliance.

Features.....	3
Precautions.....	3
Location and function of controls.....	4
System connections.....	6
Connecting a VTR or camera.....	6
Connecting several monitors.....	6
Tally connection.....	7
Specifications.....	7

INFORMATION

This equipment generates and uses radio frequency energy and if not installed and used properly, that is, in strict accordance with the manufacturer's instructions, may cause interference to radio and television reception. It has been type tested and found to comply with the limits for a Class B computing device in accordance with the specifications in Subpart J of Part 15 of FCC Rules, which are designed to provide reasonable protection against such interference in a residential installation. However, there is no guarantee that interference will not occur in a particular installation. If this equipment does cause interference to radio or television reception, which can be determined by turning the equipment off and on, the user is encouraged to try to correct the interference by one or more of the following measures:

- Reorient the receiving antenna
- Relocate the equipment with respect to the receiver
- Move the equipment away from the receiver
- Plug the equipment into a different outlet so that equipment and receiver are on different branch circuits.

If necessary, the user should consult the dealer or an experienced radio/television technician for additional suggestions. The user may find the following booklet prepared by the Federal Communications Commission helpful:

"How to Identify and Resolve Radio-TV Interference Problems".

This booklet is available from the U.S. Government Printing Office, Washington, DC 20402, Stock No. 004-000-00345-4.

FEATURES

High-resolution picture

The Microblack™ Trinitron® picture tube (PVM-8220) or the Super Fine Pitch Trinitron® picture tube (PVM-8221) gives a high resolution (PVM-8220: 250 TV lines, PVM-8221: 400 TV lines), high contrast picture.

Push-to-lock controls

In the locked position, the controls are protected from damage during carriage of the unit. The protruding position allows easier operation.

Monitor of sync signals

The H/V-DELAY switch allows horizontal and vertical sync signals to be displayed on the screen.

Blue only picture

By using the B-ONLY switch, the picture can be displayed in blue and black only, facilitating hue adjustment or observation of VTR noise.

Underscan mode

The signal normally scanned outside of the screen can be monitored in the underscan mode facilitating check of video signals.

External sync connection

The unit can operate on an external sync signal in synchronization with other VTR equipment.

Two video inputs

Two video sources can be connected to the unit. Either input can easily be switched by pressing the INPUT select switch.

By using an optional MB-504 mounting bracket, this unit can be mounted in an EIA standard 19-inch rack.

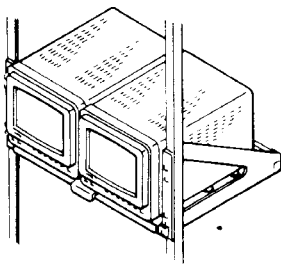

For mounting details, refer to the instruction manual of the MB-504.

PRECAUTIONS

On safety

- Operate the unit only on 120 V ac.
Use only the supplied ac power cord. Do not use any other type.
- Should any liquid or solid object fall into the cabinet, unplug the unit and have it checked by qualified personnel before operating it any further.
- Unplug the unit from the wall outlet if it is not to be used for several days.
- To disconnect the ac power cord, pull it out by the plug. Never pull the cord itself.

On installation

- Allow adequate air circulation to prevent internal heat build-up.
Do not place the unit on surfaces (rugs, blankets, etc.) or near materials (curtains, draperies) that may block the ventilation holes.
- Do not install the unit in a location near heat sources such as radiators or air ducts, or in a place subject to direct sunlight, excessive dust, mechanical vibration or shock.
- Keep the unit away from a loudspeaker or motor, as the picture may be affected.

On cleaning

To keep the unit looking brand-new, periodically clean it with a soft cloth. Stubborn stains may be removed with a cloth lightly dampened with a mild detergent solution. Never use strong solvents such as thinner or benzine, or abrasive cleansers since these will damage the cabinet. As a safety precaution, unplug the unit before cleaning it.

On repacking

Do not throw away the carton and packing materials. They make an ideal container in which to transport the unit. When shipping the unit to another location, repack it as illustrated on the carton.

If you have any questions about this unit, contact your authorized Sony dealer.

LOCATION AND FUNCTION OF CONTROLS

The photos show the PVM-8220.

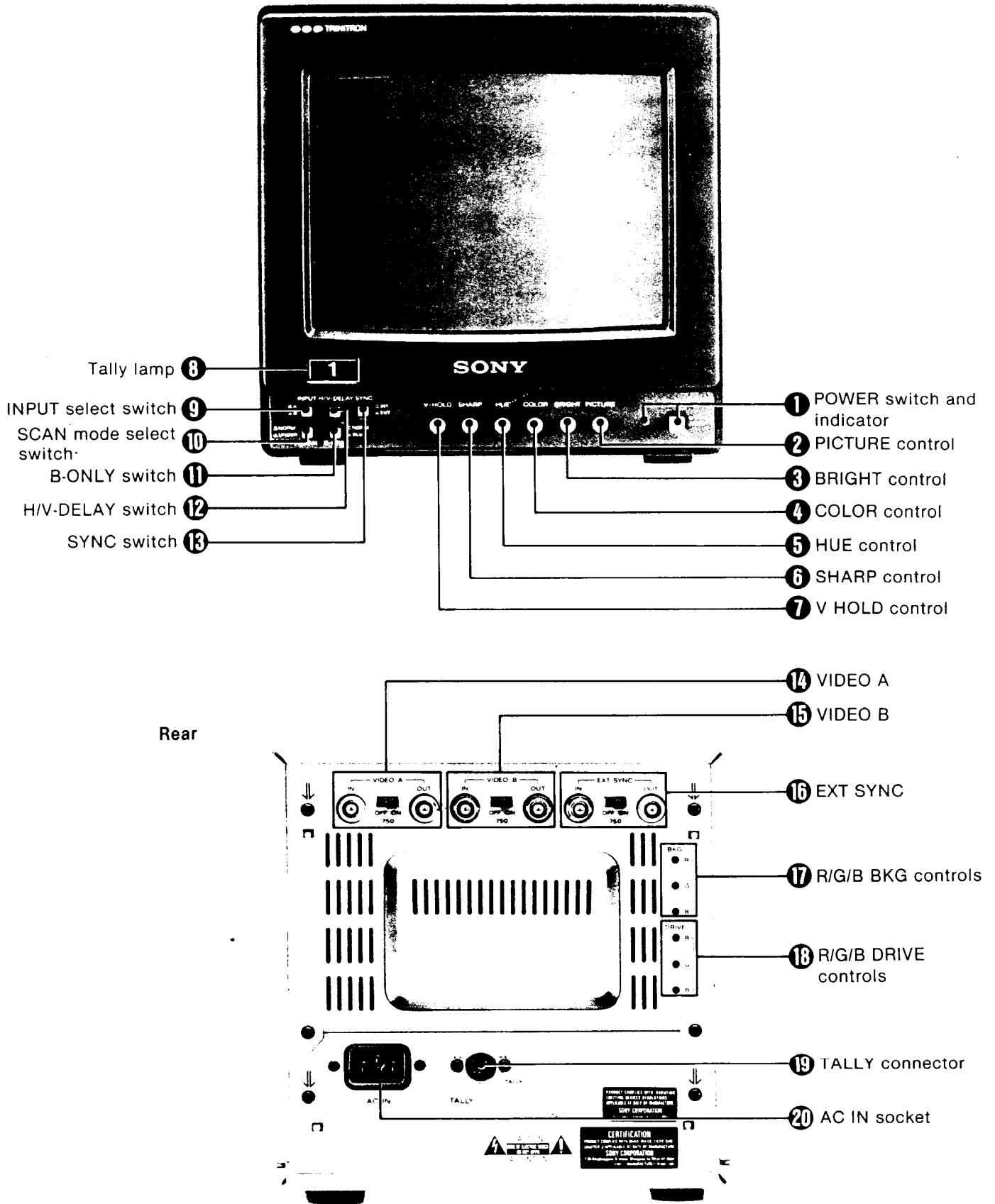

1 POWER switch and indicator

To turn the monitor on, depress the POWER switch (ON). The POWER indicator lights. To turn it off, press the switch again (OFF).

2 PICTURE control

Adjusts the contrast, intensity and brightness simultaneously in the proper ratio.

4 BRIGHT (brightness) control

Adjusts the brightness. Normally set this control at the center detent position. Clockwise rotation makes the picture brighter; counterclockwise rotation makes it darker.

4 COLOR control

Adjusts the color intensity of the picture. Clockwise rotation makes the picture more vivid; counterclockwise rotation makes it paler.

5 HUE control

Use to obtain the most natural skin tones. Clockwise rotation makes the skin tones more greenish; counterclockwise rotation makes them more purplish.

6 SHARP (sharpness) control

Adjusts the sharpness of the picture. Clockwise rotation makes the picture sharper; counterclockwise rotation makes it softer.

7 V HOLD (vertical hold) control

If the picture rolls vertically, correct it with this control.

Before turning one of the controls 2 to 7, for easier operation press on it to release the control to a protruding position.

8 Tally lamp

This lamp is turned on and off according to the signal supplied to the TALLY connector at the rear from a console or special-effects generator. To identify the monitor, insert the supplied number plate.

9 INPUT select switch

Keep this switch released (\square A) to monitor the signal from the VIDEO A IN connector. Depress the switch (\square B) to monitor the signal from the VIDEO B IN connector.

10 SCAN mode select switch

Keep this switch released (\square NORM) for normal scanning. Depress the switch (\square UNDER) to reduce the display size by about 5% (underscanning mode) and to view a picture which does not appear in normal scanning.

11 B-ONLY (blue only) switch

Normally keep this switch released (\square NORM). Depress the switch (\square BLUE) to turn off the red and green beams. The picture will be displayed in blue and black only. This facilitates hue adjustment or observation of VTR noise.

12 H/V-DELAY switch

Normally keep this switch released. To monitor the sync signals, depress the switch. The picture is shifted horizontally and vertically. The horizontal sync is displayed in left approximately one quarter of the screen and the vertical sync is displayed near the center of the screen.

13 SYNC switch

Normally keep this switch released (\square INT). The monitor is driven with the internal sync signal. To drive the monitor with an external sync signal connected to the SYNC IN connector at the rear, depress the switch (\square EXT).

14 VIDEO A, 15 VIDEO B

Two video input connectors (VIDEO A and VIDEO B) for the composite video signals and their loop-through output connectors.

To monitor the input signals connected to the VIDEO A IN connector, keep the INPUT select switch released (\square A).

To monitor the input signals to the VIDEO B IN connector, depress the INPUT select switch (\square B).

IN connector (BNC type)

Connect to the video output of video equipment, such as a VTR or a color video camera.

OUT connector (BNC type)

Loop-through output of the IN connector. Connect to the video input of a VTR or another monitor.

75 Ω termination switch

When only the IN connector is used (the OUT connector is not used), set this switch to ON. When both the IN and OUT connectors are used together for a loop-through connection, set the switch to OFF.

16 EXT SYNC (external sync)**IN connector (BNC type)**

When this monitor operates on an external sync signal, connect the reference signal from a sync generator to this connector.

OUT connector (BNC type)

Loop-through output of the EXT SYNC IN connector. Connect to the external sync input of video equipment to be synchronized with this monitor.

75 Ω termination switch

When only the EXT SYNC IN connector is used (the EXT SYNC OUT connector is not used), set this switch to ON. When both the EXT SYNC IN and OUT connectors are used together for a loop-through connection, set the switch to OFF.

17 R/G/B BKG (background) controls

Used for adjusting the white balance of the background.

18 R/G/B DRIVE controls

Used for adjusting the white balance at the white peak.

19 TALLY connector (4-pin DIN)

Connect to the tally output of a control console, special-effects generator, etc. The tally light on the front panel will be turned on or off by the connected console or special-effects generator.

20 AC IN socket

Connect the supplied ac power cord to this socket and to a wall outlet.

SYSTEM CONNECTIONS

CONNECTING A VTR OR CAMERA

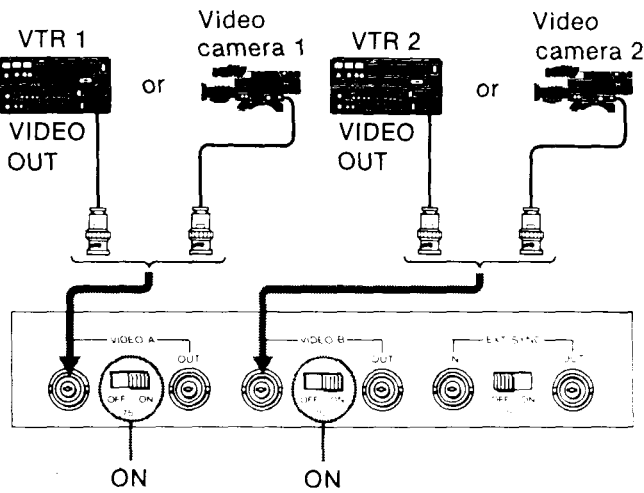

CONNECTING SEVERAL MONITORS

A loop-through connection is convenient for monitoring the same signal on several monitors. Use the OUT connectors of VIDEO A and VIDEO B. Up to 10 monitors can be connected for each group. Set the 75 Ω termination switch of the last monitor to ON and those of the other monitors to OFF.

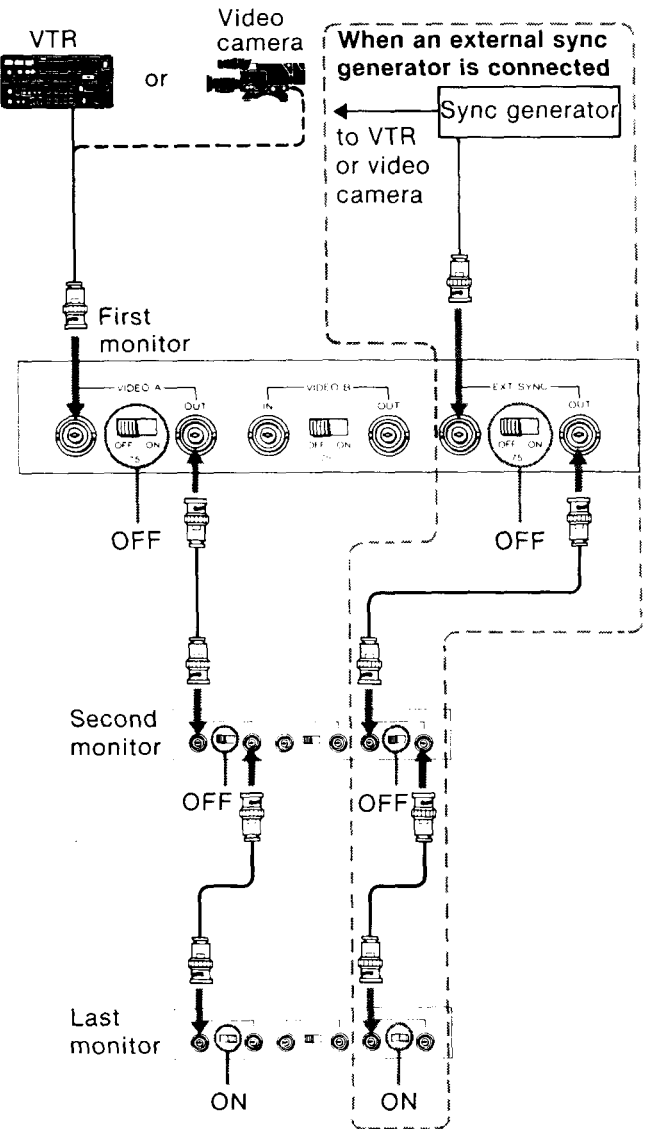

When an external sync generator is connected, depress the SYNC switch (EXT) on each monitor.

TALLY CONNECTION

To utilize the tally-lamp feature of this monitor, connect the TALLY connector at the rear of the monitor to a control console, special-effects generator, etc. using the supplied tally connector. The No.1 (ground) and No.2 (tally) pins should be connected to the corresponding pins of the tally out connector.

The tally lamp on the front panel will be turned on or off by operating the console or special-effects generator.

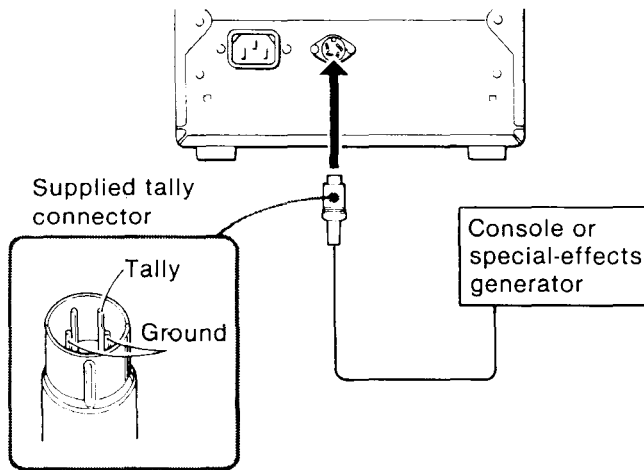

How to use the supplied number plate

To identify the monitor in your system, insert the supplied number plate under the tally lamp cover. When the tally lamp lights, the number will be illuminated.

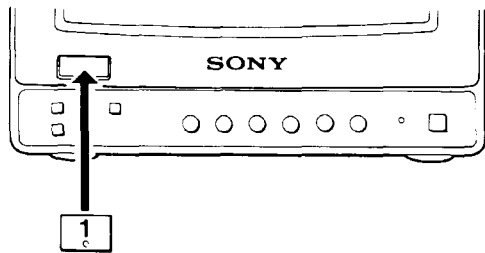

SPECIFICATIONS

Color system	NTSC system
Picture tube	PVM-8220 : Microblack Trinitron tube PVM-8221 : Super Fine Pitch Trinitron tube 8-inch picture measured diagonally, 70-degree deflection
Resolution	PVM-8220 : 250 TV lines (B/W) PVM-8221 : 400 TV lines (B/W)
Color temperature	6500°K
Frequency response	PVM-8220 : 4 MHz (-3 dB) PVM-8221 : 5.5 MHz (-3 dB)

Horizontal linearity	±8%
Vertical linearity	±8%
Line pull range	Horizontal ±500 Hz
Overscan of the picture	6%
Underscan of the picture	5%
H/V delay	Horizontal : Approx. 1/4 line Vertical : Approx. 1/2 field
Return loss	5 MHz, -30 dB (VIDEO A IN, VIDEO B IN)
Zooming	Within 3%
Convergence	Central area 0.5 mm Periphery 0.7 mm
Brightness	PVM-8220 : More than 50 foot-lamberts PVM-8221 : More than 30 foot-lamberts
Inputs	VIDEO IN (VIDEO A, VIDEO B) : BNC connector Composite 1 V p-p ±6 dB, 75 ohms, unbalanced, sync negative Non-composite 0.7 V p-p EXT SYNC IN : BNC connector Composite sync 4 V p-p ±6 dB, sync negative, 75 ohms and high impedance switchable
Loop-through outputs	VIDEO OUT (VIDEO A, VIDEO B) : BNC connector Composite 1 V p-p ±6 dB, 75 ohms, unbalanced, sync negative Non-composite 0.7 V p-p EXT SYNC OUT : BNC connector Composite sync 4 V p-p ±6 dB, sync negative, 75 ohms and high impedance switchable
TALLY connector	4-pin DIN connector
Power requirements	120 V ac, 50/60 Hz
Power consumption	30 W ac, max.
Dimensions	Approx. 216 × 219 × 319 mm (w/h/d) (8 ⁵ / ₈ × 8 ⁵ / ₈ × 12 ⁵ / ₈ inches) incl. projecting parts and controls
Weight	Approx. 7.5 kg (16 lb 9 oz) not incl. accessories
Accessories supplied	AC power cord (1) Tally connector (4-pin DIN) (1) Number plate (1 set)
Optional accessory	Mounting bracket MB-504

Design and specifications subject to change without notice.